







Produktdatenblatt REF 58.54.08

11.12.2025

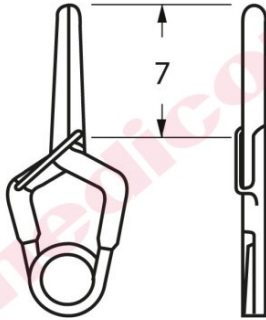
Allgemeine Daten			
Artikel	58.54.08	Yasargil Stand Clip ger p7mm	
VK-Einheit	Stück	Zoll Nr.	90219090
GMDN Code	34958	GTIN	04046826092139
Risikoklasse	3 (EU MDD)	UMDNS-Code	10-905
Klassifizierung	8 (EU MDD)	Basis UDI-DI	
Gewicht (kg)	0,002	Gebrauchsanweisung	G585408
Latex frei	nicht zutreffend	Aufbereitungsanweisung	MPK18
  			
Medicon Medien			
Hauptbild		Detailbild	
			
Maße	7mm	Beschichtung	
Lagerungsbedingungen			
Keine besonderen Lagerungsbedingungen erforderlich			
Werkstoffe			
	Werkstoff-Nr. (DIN Bezeichnung)		
Hauptteil	2.4711 (CoCr20Ni15Mo)		