







Ficha técnica REF 58.42.07

11.12.2025

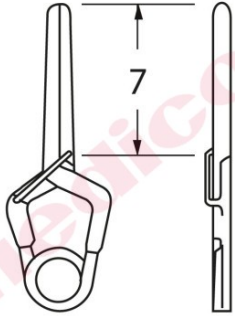
Datos generales			
Referencia	58.42.07	Yasargil Mini Ti clip rct 7mm p	
Unidad	unid.	Número de aduana	90219090
GMDN	34958	GTIN	04046826090661
Clasificación	3 (EU MDD)	UMDNS-Code	10-905
Clasificación	8 (EU MDD)	Base UDI-DI	
Peso neto (kg)	0,003	Manual de uso	G585408
Latex free	si	Instrucciones de preparación	MPK18
  			
Medicon medios			
Imagen completa		Imagen detallada	
			
Medida	7mm	Revestimiento	
Condiciones de almacenamiento			
No se requieren condiciones especiales de conservación			
Material			
	N° de material (Denominación DIN)		
Cuerpo	3.7165 (ASTM_Grade_5_TiAl6V4_(ELI))		